

PROGRAM

hidrobox®

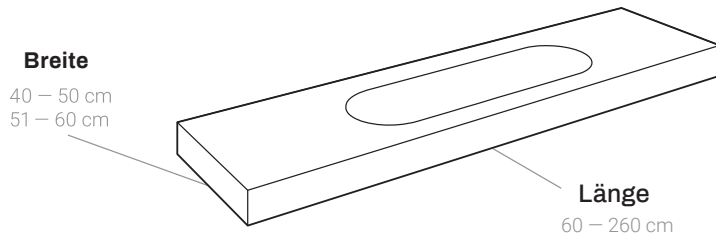

Schürze

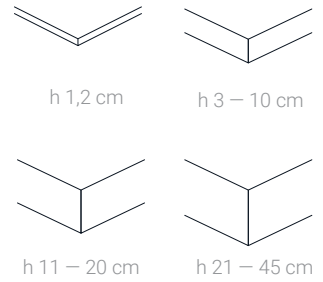

RECTANGULAR



S23 25 x 35 x 14h



S1 30 x 40 x 14h



S2 30 x 70 x 14h

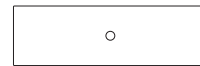

S3 31 x 100 x 14h

RECTANGULAR T



S4 30 x 40 x 14h



S5 30 x 70 x 14h



S6 31 x 100 x 14h

CITY 14



S30 22 x 35 x 14h



S24 25 x 40 x 14h



S7 31 x 50 x 14h



S8 31 x 80 x 14h



S9 31 x 100 x 14h

CITY 10



S35 22 x 35 x 10h



S34 25 x 40 x 10h

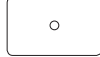

S31 31 x 50 x 10h

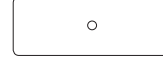

S32 31 x 80 x 10h

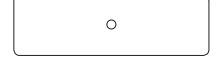

S33 31 x 100 x 10h

LINE



S10 30 x 50 x 9h

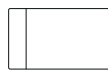

S11 30 x 50 x 9h



S12 30 x 75 x 9h



S13 30 x 75 x 9h

OVAL

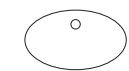

S14 29 x 50 x 14h

COLISO 14



S25 25 x 40 x 14h



S15 30 x 50 x 14h



S16 31 x 100 x 14h

CIRCULAR 13



S26 30 x 30 x 13h



S17 39 x 39 x 13h

COLISO 10



S38 25 x 40 x 10h



S36 30 x 50 x 10h

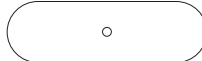

S37 31 x 100 x 10h

CIRCULAR 10



S40 30 x 30 x 10h



S39 39 x 39 x 10h

BETA



S18 33 x 54 x 14h

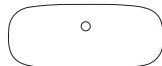

S19 34 x 80 x 14h

ESFERA



S20 34 x 34 x 14h

ARCO



S21 30 x 50 x 14h

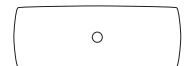

S22 31 x 80 x 14h

1 SIPHON

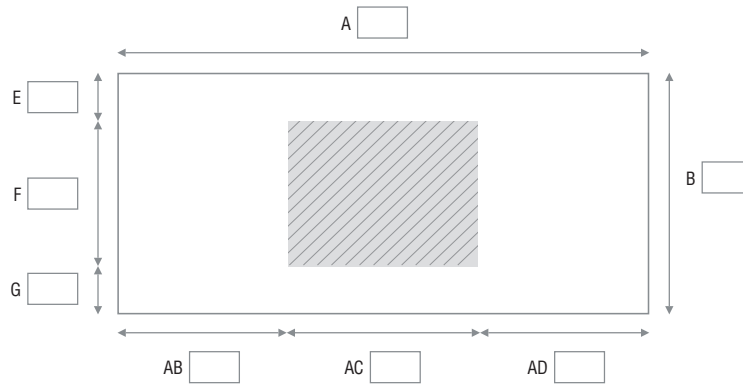

2 SIPHONS

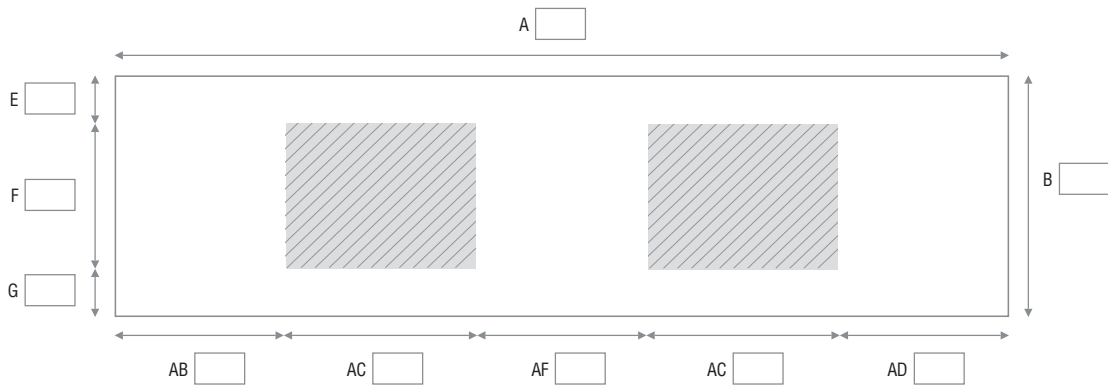

ANGABEN FÜR DIE POSITIONIERUNG DER SIPHONS

	h = 1,2		h = 3-45		AB/AD	h = 1,2		h = 3-45
	Ohne Armatur	Mit Armatur	Ohne Armatur	Mit Armatur		Ohne Halterungen	Mit Halterungen	
E	4	8	4	8	4	5	10	
G	4	4	6	6	10	10	10	

1 HANDTUCHHALTER AN FRONTALER BLENDE

2 HANDTUCHHALTER AN FRONTALER BLENDE

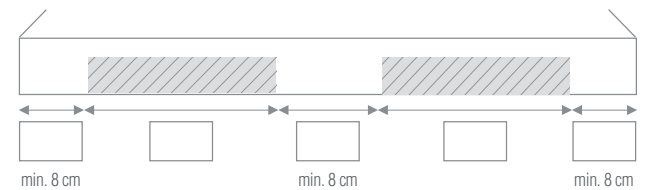
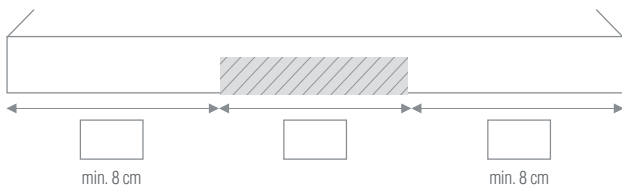

Integrierter 35/45 cm
 Handtuchhalter unter der tischfläche 30/40/50 cm
 2 Befestigungselementen 30/40/50 cm
 1 Befestigungselemente 30/40/50 cm

HANDTUCHHALTER AN LINKER BLENDETOWEL

HANDTUCHHALTER AN RECHTER BLENDETOWEL

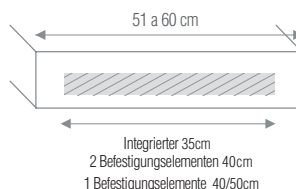
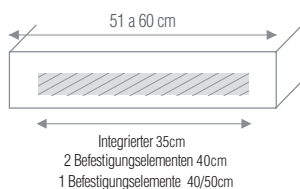
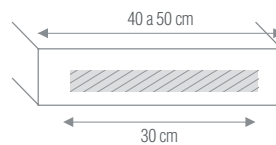
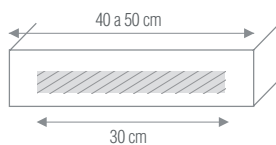

Integrierter
 2 Befestigungselementen
 1 Befestigungselemente

Montage

1

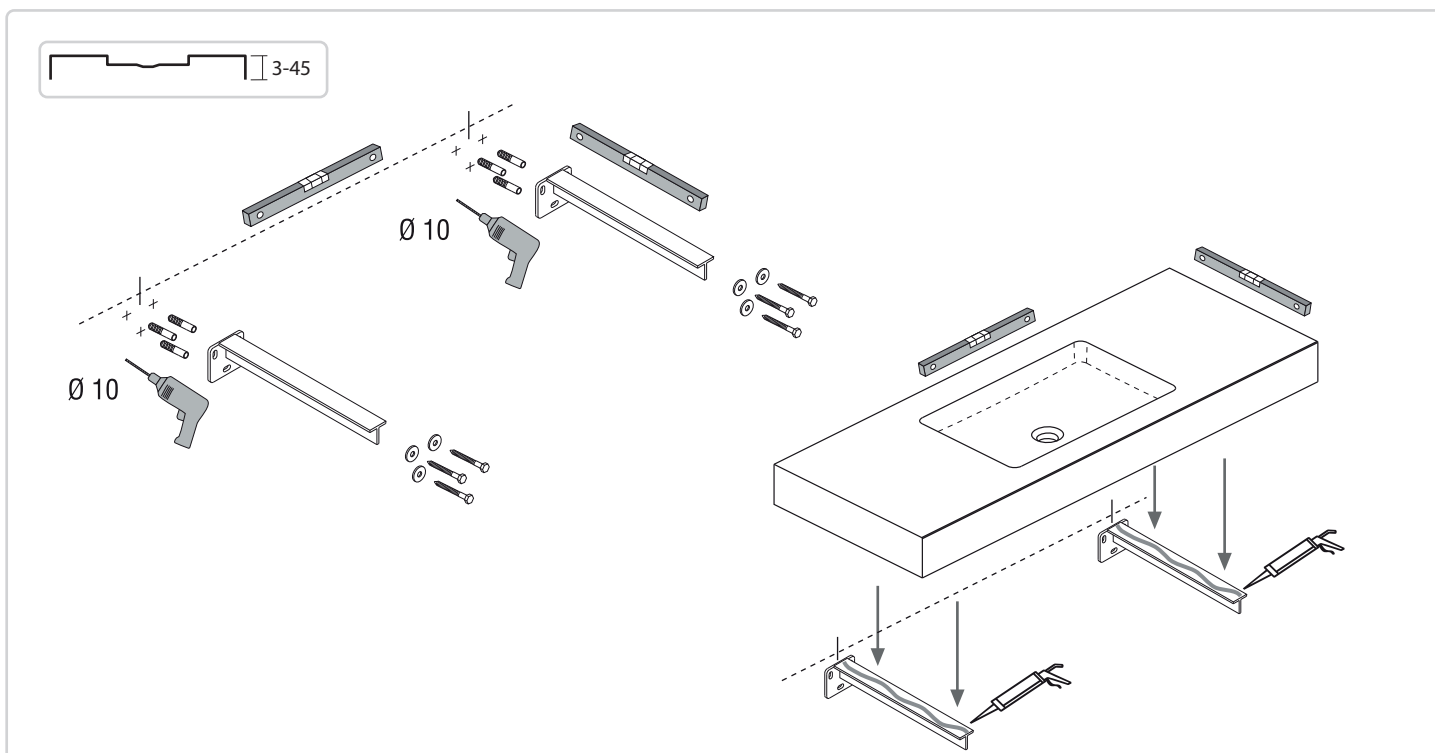

1.2

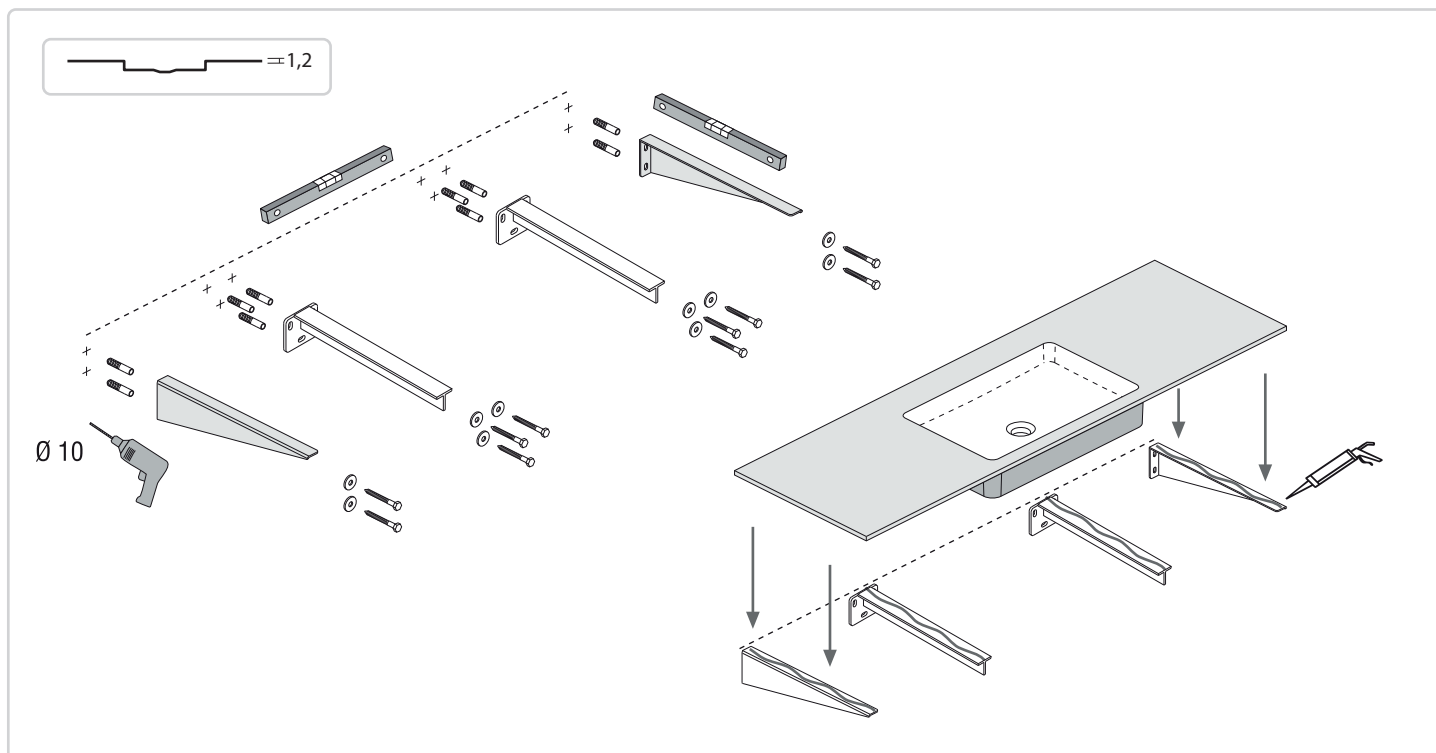

Montage

1.3

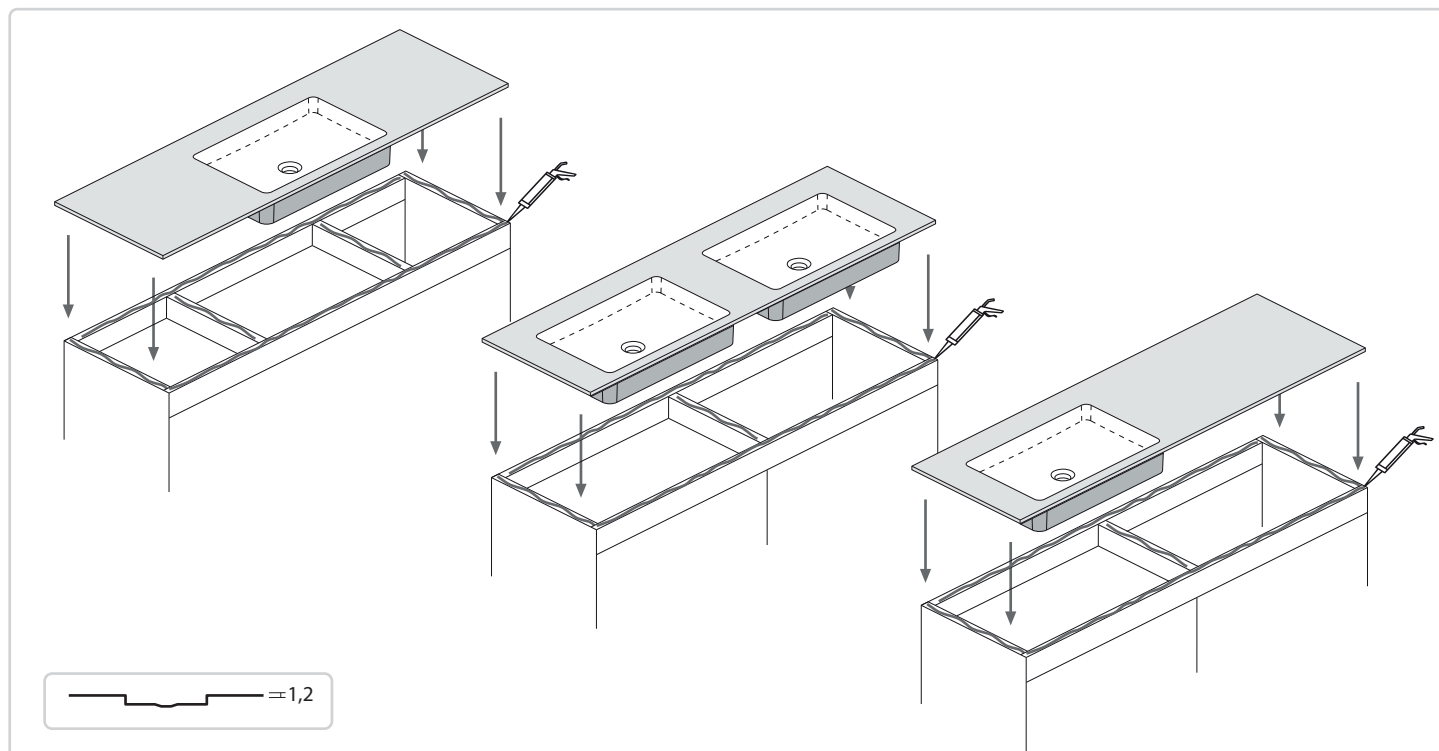

Klebstoffe und andere (geliefert bei hidrobox)



Silikondichtstoff
310 ml Kartusche